

Ingersoll Rand

Oil-free Compressed Air Technology

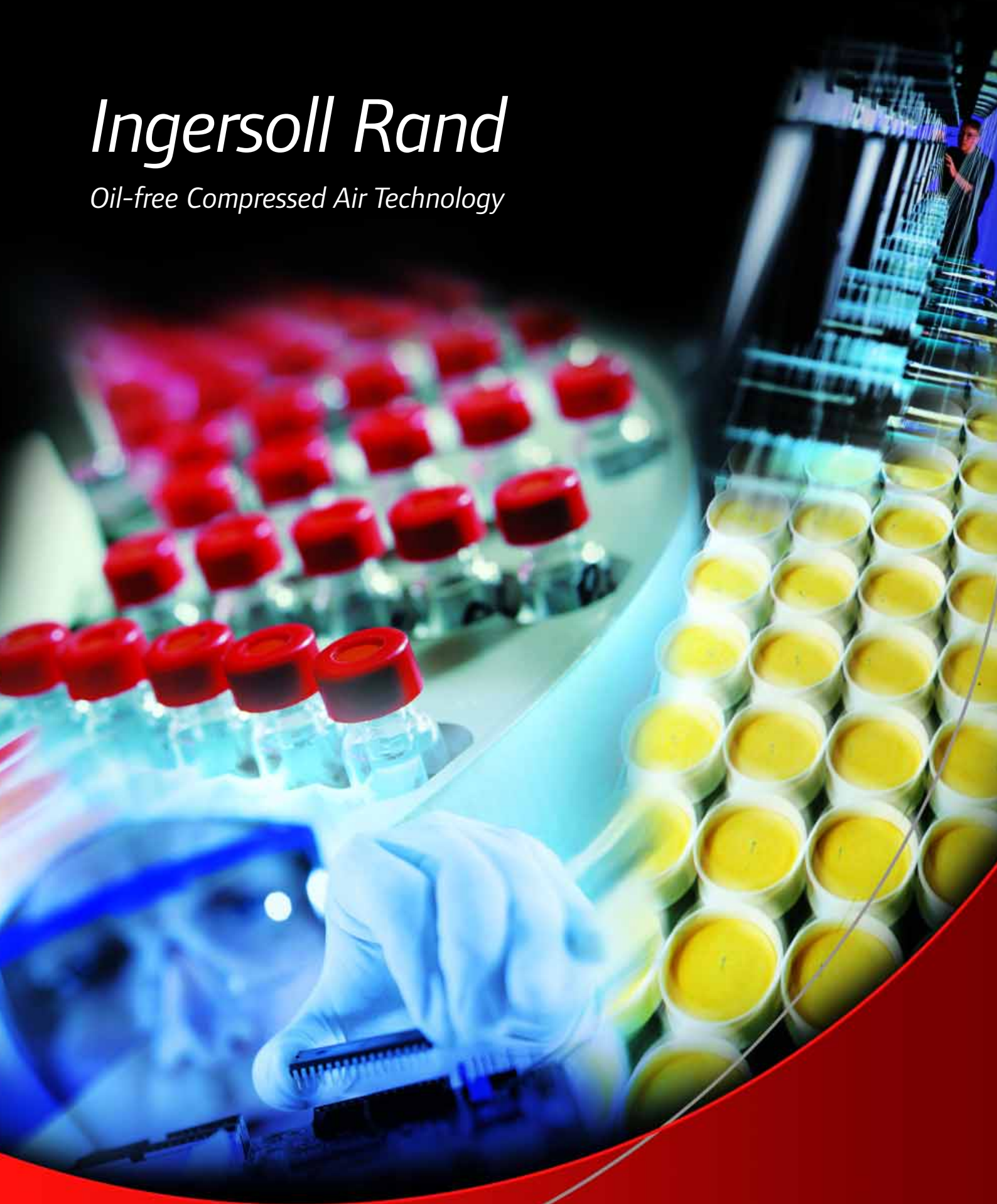

More than air, a history of innovation

1906 Ingersoll Rand becomes publicly traded company on NYSE



1933 Technologically advanced oil-free reciprocating compressor goes to market

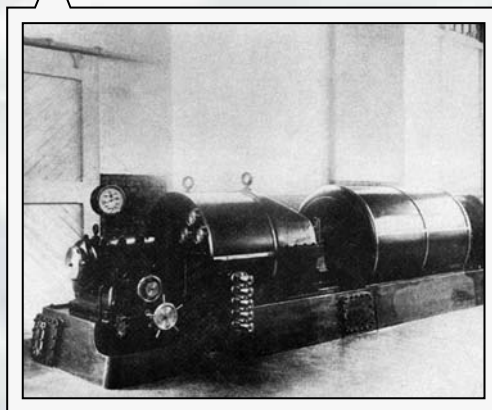
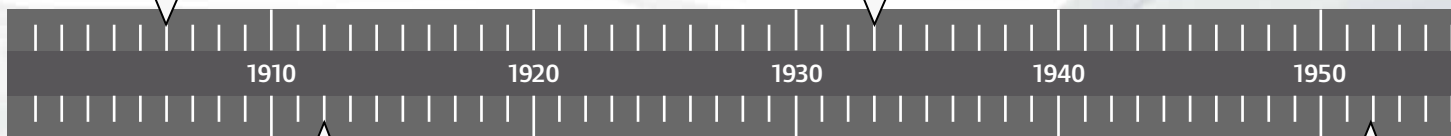
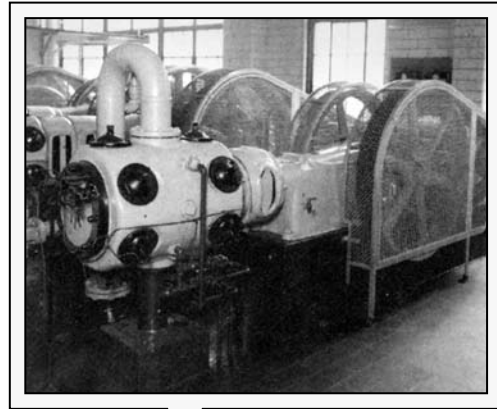

1912 Ingersoll Rand pioneers oil-free centrifugal compressor technology

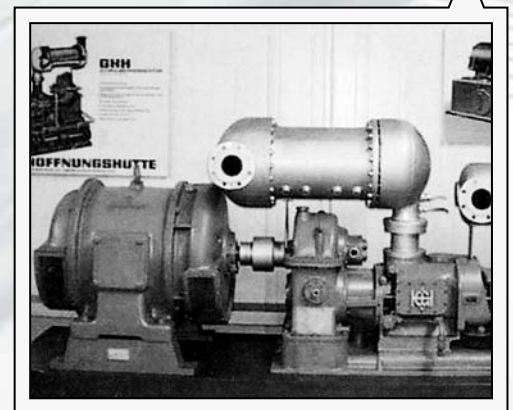

1952 The world's first oil-free rotary compressor is introduced

For more than 100 years, Ingersoll Rand has inspired progress by driving innovation with revolutionary technology — creating new standards for how the world gets work done. We introduced our first oil-free compressor in 1912, and over the decades we've continued to develop rugged, reliable, industry-leading compressor technologies.

Ingersoll Rand is the technology leader in oil-free compressed air not only because we develop class-leading products, but also because we know our customers' industries, understand the demands placed on productivity and quality, and then offer highly engineered system solutions that make sense. No matter what your product, process, or location, Ingersoll Rand has the expertise, the oil-free technology, and the unmatched service to meet your needs.

2003 Ingersoll Rand offers industry's first true variable-speed drive, oil-free compressor featuring HPM® motor technology

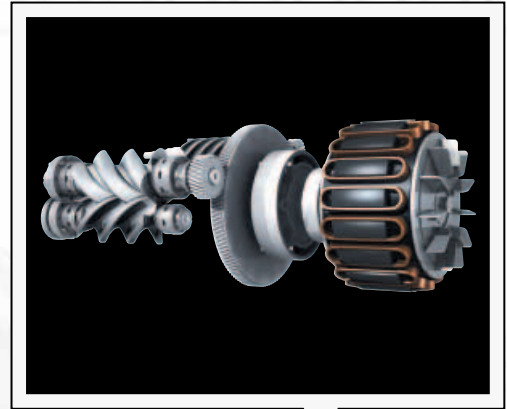

1960

1970

1980

1990

2000



1968 First packaged centrifugal compressor is introduced (current model shown)



1993 The 37 – 300 kW packaged rotary-screw compressor introduced featuring Intellisys™, UltraCoat™ rotor protectant, and 46°C design

When high air purity is a high priority

Oil-free



Food and Beverage ▲

Oil-free compressors that deliver no oil into the air stream and minimise microbial content through high-temperature compression reduce contamination risk for food and beverage manufacturers.



Pharmaceutical ▲

The highly regulated pharmaceutical industry requires 100% total quality built into manufacturing processes. Compressed air quality must be validated as part of GMP.



Electronics ▲

High air quality is critical in this industry — you can't afford downtime or product spoilage with wet or oily compressed air.

There's a lot riding on the quality of your air. The presence of particles, condensation, oil, and oil vapour in a compressed air system can lead to downtime, product spoilage and recall, damage to your brand reputation, or worse, harmed consumers and product liability.



Chemical ▲

Whether manufacturing cleaning solutions, base stock pharmaceuticals, or anything in between, the compressed air quality must be of the highest purity to minimise risk of production interruption or higher cost liability.



Textile ▲

High-tech air jet looms require super clean, dry, 100% oil-free compressed air, which is why Ingersoll Rand has been a critical supplier to this industry for many years.



Utilities ▲

Compressed air quality is too important to risk, so when specifying instrument air for utilities, most engineers request oil-free compressors.

No matter what industry or critical application, you can count on Ingersoll Rand to offer solutions that mitigate risk and ensure delivery of the highest air purity possible.

Oil-free, risk-free

How pure is your air? One of the keys to ensuring you achieve and maintain acceptable air quality for your critical application is to know industry air quality standards and their allowable levels of contaminants. The lower the particular class rating, the purer the air should be.

ISO 8573-1:2001 Air Quality Classes

Quality Class	SOLIDS			WATER		OIL & OIL vapour	Quality Class
	0.1 – 0.5 micron	0.5 – 1 micron	1 – 5 micron	Pressure Dew Point °F	°C	mg/m ³	
0	As specified by the end-user or manufacturer, and more stringent than Class 1						0
1	100	1	0	-100	-70	0.01	1
2	100,000	1000	10	-40	-40	0.1	2
3	N/A	10,000	500	-4	-20	1	3
4	N/A	N/A	1,000	37.4	3	5	4
5	N/A	N/A	20,000	44.6	7	N/A	5
6	N/A	N/A	N/A	50	10	N/A	6

ISO 8573-1:2001 Class 0 specifies air quality standards for critical manufacturing processes within the food and beverage, pharmaceutical, textile, and electronics industries. It is the most stringent class, covering oil contamination in aerosol, vapour, and liquid forms.

Some compressor manufacturers have marketed their units as being *essentially* oil-free, but this isn't necessarily the case. If you need *guaranteed* pure air for your critical application, then you need Ingersoll Rand.



Oil-free compressors in a class by themselves

With an Ingersoll Rand oil-free compressor, you don't have to worry about contaminated air, regardless of the technology you choose.

Our oil-free rotary-screw and centrifugal compressors were rigorously tested by TÜV Rheinland® — a global leader in independent testing and assessment services — and earned ISO 8573-1:2001 Class 0 certification.

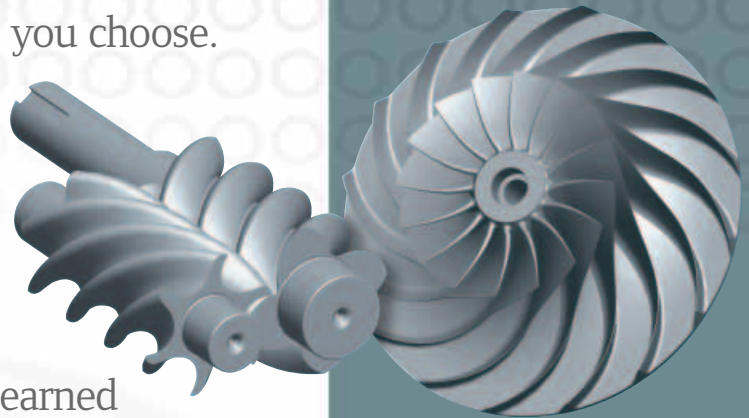

Only Ingersoll Rand delivers ISO Class 0 in both rotary-screw and centrifugal technologies. Whether you're in food and beverage, pharmaceuticals, electronics, or any other critical application, count on Ingersoll Rand oil-free technology to deliver pure air and peace of mind.

Unleashing the full potential of variable-speed technology

If you have a critical oil-free application requiring the lowest operating cost, you can't afford to take chances with a compressor system that delivers anything but the absolute highest quality air, reliability, and efficiency. Not a problem with an Ingersoll Rand Nirvana — the world's first true variable-speed drive (VSD) oil-free compressor system.



Purely better

While other variable-speed drive (VSD) compressors also deliver stable pressure, soft-starting, and improved part-load efficiency over fixed-speed compressors, only Nirvana enables you to reach the full potential of variable-speed technology. With a Nirvana system, you get ultra-reliability and efficiency, virtually maintenance-free operation, unlimited starts and stops, and peace of mind knowing your air is 100% pure.

Nirvana HPM® Technology

Nirvana technology vs. competitive VSD compressors

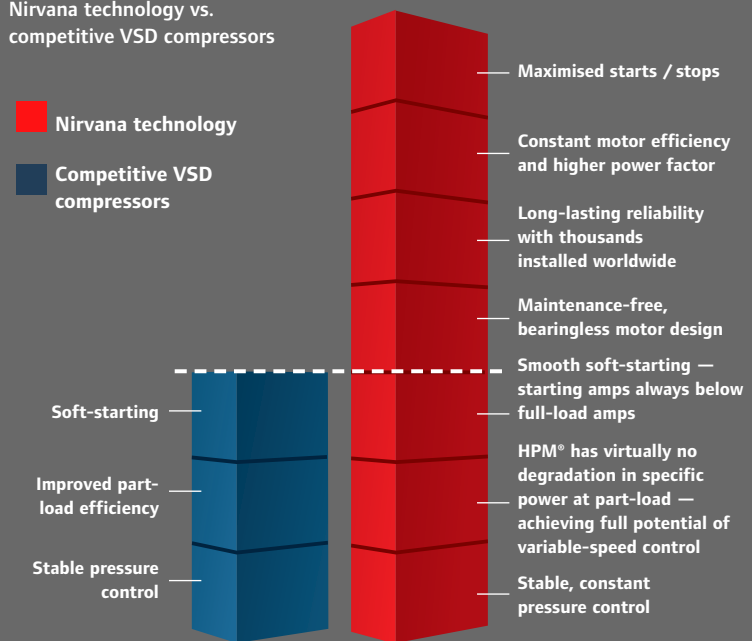

Real savings, real satisfaction

Energy costs can be as much as 60% of the lifecycle cost of an air compressor. The Nirvana system helps you reach the full potential of variable speed through the absolute lowest energy cost and the highest efficiency possible.

Rotary 10-year Lifecycle Cost

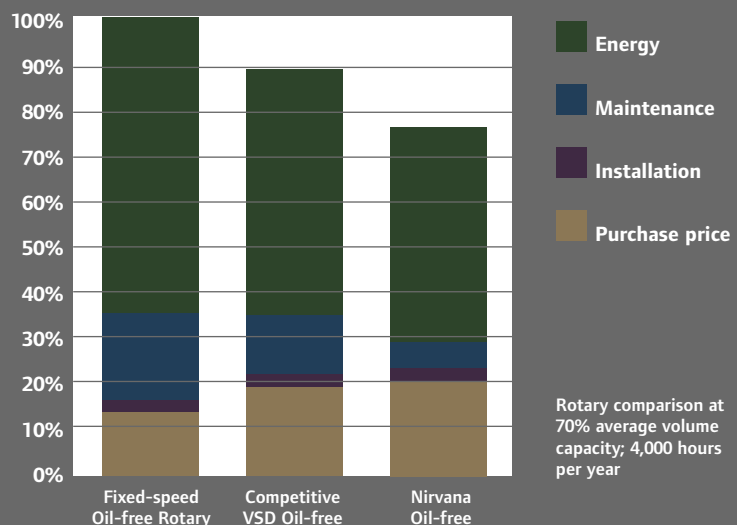

Achieve a higher plane of performance

There's never been a compressor system as advanced as Nirvana. It's synergy in motion — a combination of transcendent, inter-dependent technologies including the revolutionary Hybrid Permanent Magnet® (HPM®) motor, and more than a century of proven engineering expertise and innovation.

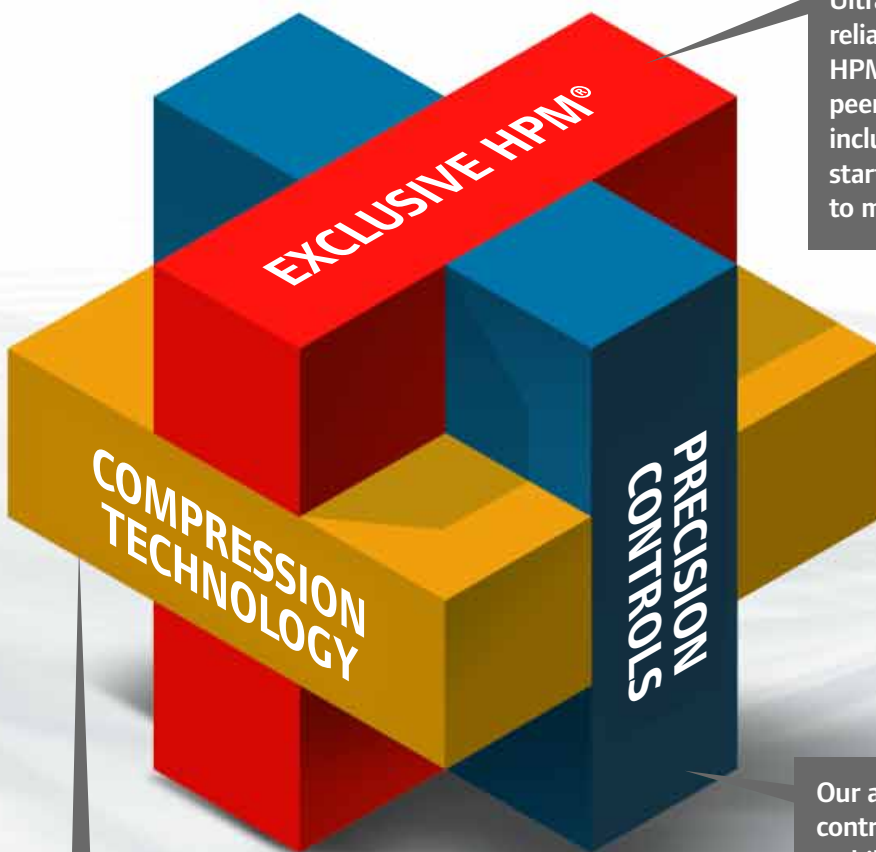

Ultra-efficient and reliable, the Nirvana HPM® motor delivers peerless performance, including the ability to start and stop limitlessly to meet demand.

Only Ingersoll Rand combines more than a century of proven engineering and compression technologies with the state-of-the-art UltraCoat surface protection coating for unmatched performance and durability.

Our advanced air system controllers enable you to stabilise air pressure, reduce energy costs, extend the life of system components, and prevent off-quality product.

Nirvana adv

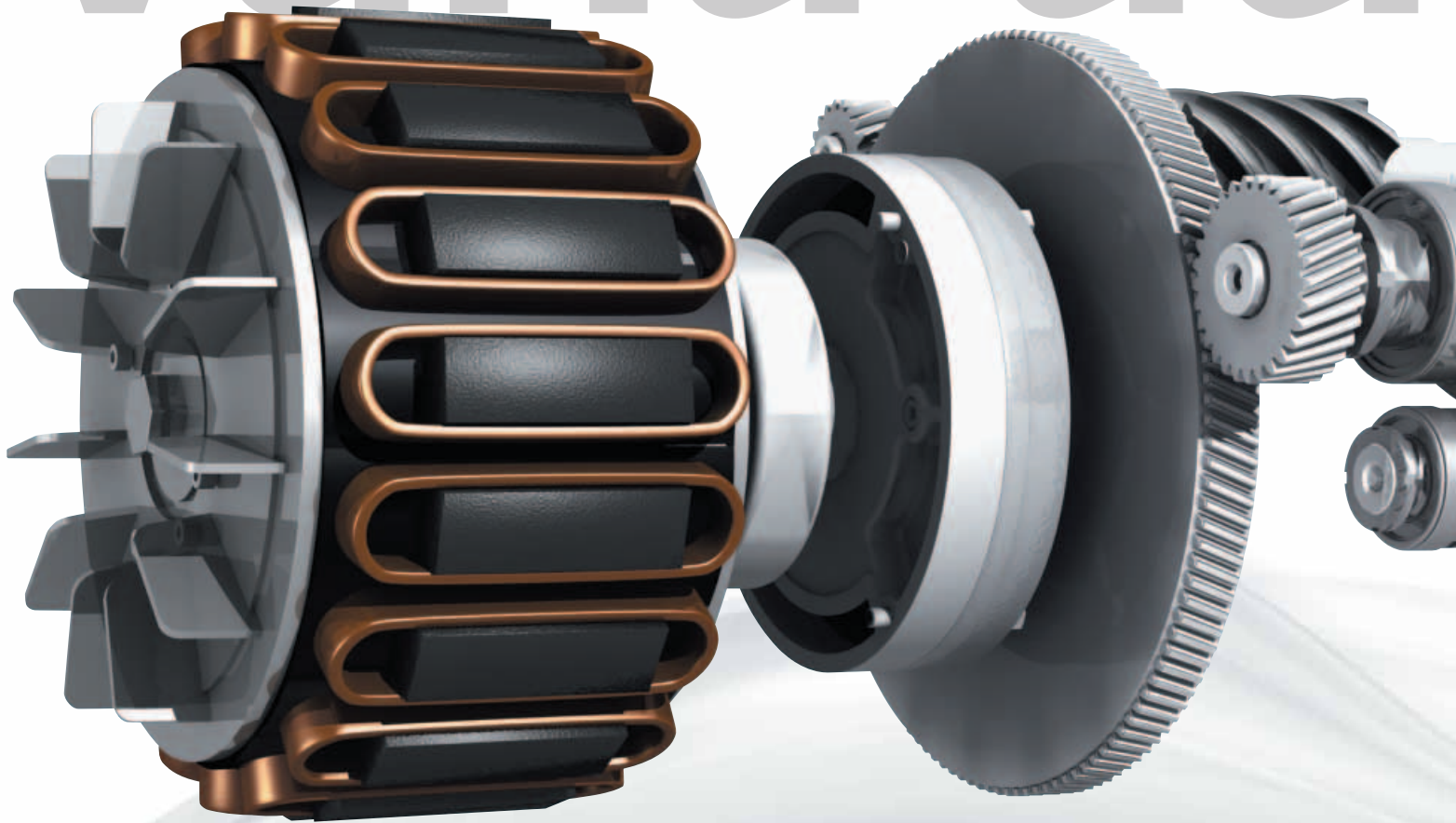

Limitless starts and stops

Nirvana is designed to start and stop limitlessly to meet your compressed air demands while never going above full-load amps. HPM® motor technology also has unmatched efficiency throughout the turn-down range, providing savings no matter what your demand profile requires.

No wasted energy

The Nirvana HPM® motor requires less power at start-up, never operates at more than full-load amps, and shuts down immediately at minimum speed to avoid wasted energy. Nirvana ensures constant pressure throughout the entire operating range. At start-up, induction motors require a power surge of up to twice full-load current in order to overcome initial inertia. They also run unloaded when demand is below minimum, reducing efficiency and driving up energy costs.

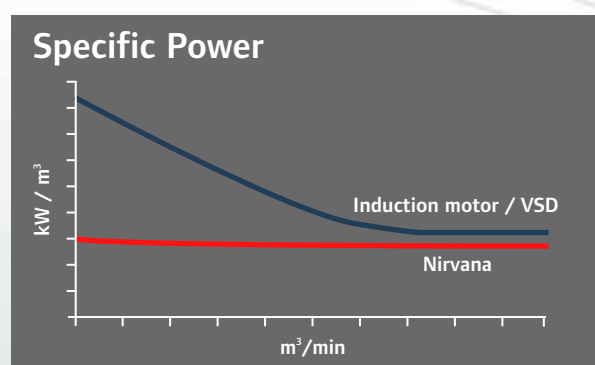

vantage



A revolutionary motor coupled with advanced controls and proven compressor technologies.

Proven airends

Our rotary-screw airends deliver full potential through unparalleled rotor profile accuracy and repeatability. Stainless-steel rotors are used in the demanding second stage for maximum corrosion resistance. UltraCoat surface coating is also applied to the rotors and all housing surfaces for unmatched durability and performance.

Simpler and more reliable

The Nirvana HPM® motor has fewer moving parts, and flanges directly onto the compressor drive shaft, making the motor more reliable and 100% maintenance-free. Its bearing-free design eliminates the need for greasing or replacing motor bearings. The HPM® motor is also designed to operate continuously in temperatures up to 46°C (115° F).



Precision-wound

With its precision-wound design, the Nirvana HPM® motor eliminates inefficiencies and hot spots common to conventional, random-wound induction motors. These hot spots can cause insulation and motor failure.

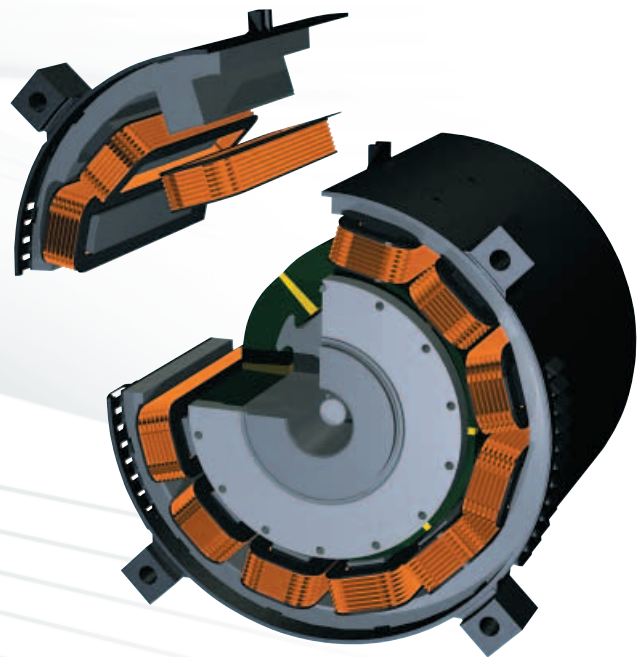

Perfect solutions for critical operations

50 Hz									
Model (HPM® Style)	FAD (m³/min) at 7 bar g	FAD (m³/min) at 8.6 bar g	FAD (m³/min) at 10.3 bar g	Discharge Air BSPT in	Nominal kW	Width mm	Length mm	Height cm	Weight kg
IRN37K-OF	5.66	5.07	4.50	1.5	37	1120	2080	2030	1632
IRN45K-OF	6.71	6.20	5.61	1.5	45	1120	2080	2030	1632
IRN55K-OF	9.37	8.47	7.62	1.5	55	1320	2080	1950	2045
IRN75K-OF	12.32	11.33	10.42	1.5	75	1320	2080	1950	2045
IRN90K-OF	15.4	13.7	12.1	2	90	1830	2570	2440	3222
IRN110K-OF	18.8	17.1	15.4	2	110	1830	2570	2440	3222
IRN132K-OF	22.3	20.4	18.6	2	132	1830	2570	2440	3222
IRN160K-OF	25.6	24.4	22.8	2	160	1830	2570	2440	3222

Model (Induction/ Inverter Style)	FAD (m³/min) at 7 bar g	FAD (m³/min) at 8.6 bar g	FAD (m³/min) at 10.3 bar g	Discharge Air ANSI Fig in	Nominal kW	Length x Width x Height mm	Weight kg
S250-VSD	45.2	40.5	35.5	4	250	3050 x 1930 x 2440 (air-cooled)	4766
S300-VSD	48.8	46.7	43.3	4	300	3050 x 1930 x 2030 (water-cooled)	4902

Models S250 and S300-VSD include the inverter shipped loose for mounting in motor control room or location of customer preference. Inverter Unit is pre-engineered for plug-and-play and is 2000 mm H x 600 mm L x 538 mm W.

60 Hz									
Model (HPM® Style)	FAD at 100 psig cfm	FAD at 125 psig cfm	FAD at 150 psig cfm	Discharge Air BSPT in	Nominal hp	Width in	Length in	Height in	Weight lbs
IRN50H-OF	200	180	159	1.5	50	44	82	80	3590
IRN60H-OF	237	220	198	1.5	60	44	82	80	3590
IRN75H-OF	331	299	269	1.5	75	52	81.8	76.7	4500
IRN100H-OF	435	400	368	1.5	100	52	81.8	76.7	4500
IRN125H-OF	563	504	444	2	125	72	101	96.1	7088
IRN150H-OF	676	616	555	2	150	72	101	96.1	7088
IRN200H-OF	881	816	751	2	200	72	101	96.1	7088

Model (Induction/ Inverter Style)	FAD at 100 psig cfm	FAD at 125 psig cfm	FAD at 150 psig cfm	Discharge Air ANSI Fig in	Nominal hp	Length x Width x Height in	Weight lbs
350-VSD	1,600	1,501	1,330	4	350	120 x 76 x 96 (air-cooled)	10485
400-VSD	1,730	1,650	1,501	4	400	120 x 76 x 80 (water-cooled)	10785

Models 350 and 400-VSD include the inverter shipped loose for mounting in motor control room or location of customer preference. Inverter unit is pre-engineered for plug-and-play and is 78.7" H x 23.6" W x 21.2" D.

Two-stage, oil-free rotary-screw air compressors

The reliable workhorse. Since its introduction in 1993, the Ingersoll Rand oil-free rotary-screw compressor has earned a reputation for being a highly reliable supplier of pure air. Its rugged design sets the standard for efficiency and durability. With an Ingersoll Rand oil-free rotary-screw compressor in your operation, you benefit from knowing you can run 24-hours a day, seven days a week with virtually no downtime.



Superior technology

Our time-proven two-stage compression module features precision-machined rotors and gearing, advanced UltraCoat rotor protection, anti-friction bearings, stainless-steel air seals, and a unique labyrinth oil seal design — all ensuring years of reliable, trouble-free operation.

Oil-free heritage

Over the years, Ingersoll Rand has delivered more than 100,000 sets of oil-free rotors to industries that rely on high-purity products such as pharmaceuticals, food and beverages, and electronics.

Stainless-steel rotors

Ingersoll Rand pioneered the use of stainless-steel rotors in the demanding second stage to guarantee longer airend life, and to safeguard the quality of your compressed air.

Inlet valve superiority

Ingersoll Rand uses hydraulic valve actuation instead of pneumatic controls. This eliminates the need for periodic diaphragm replacement, preventing unnecessary downtime and maintenance costs.

Dual-vented seals

Our stainless-steel ring seals and labyrinth oil seals provide dual-vented, 100% guaranteed oil-free air.

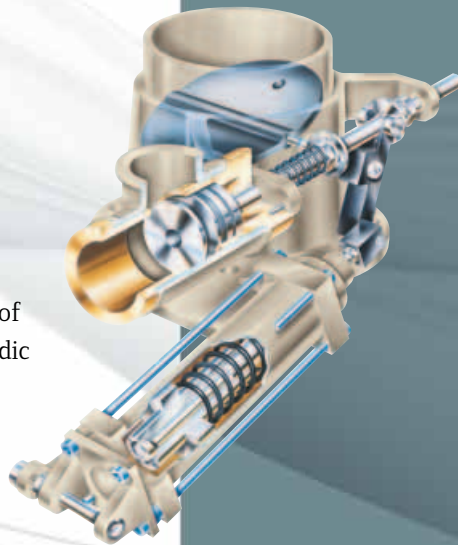
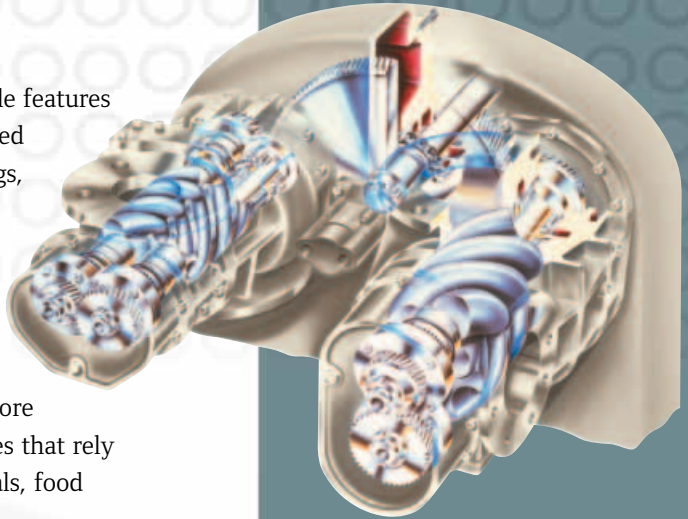

UltraCoat™ — energy savings and longer life

Compressor rotors take a beating. Over time their surfaces can deteriorate, making rotors increasingly susceptible to compressed air impurities and temperature fluctuation, which lead to reduced efficiency, decreased air purity, and compressor failure.

Ingersoll Rand eliminates this problem with UltraCoat, an advanced rotor and housing protection process that ensures the most durable coating, with unmatched adhesion and temperature resistance.

Every Ingersoll Rand oil-free rotor and housing is specially prepared, creating a surface texture to which the UltraCoat micro-coating bonds with the tightest, longest-lasting grip possible.

We also use stainless-steel and aluminum piping to link the compressor's intercooler with the stainless-steel second stage rotors. This way, condensation during the cooling process won't cause corrosion or rust, further extending the life of the UltraCoat coating and rotors.

Ultimately, UltraCoat delivers greater reliability in performance and air quality, rotor longevity, increased uptime, and reduced energy costs.

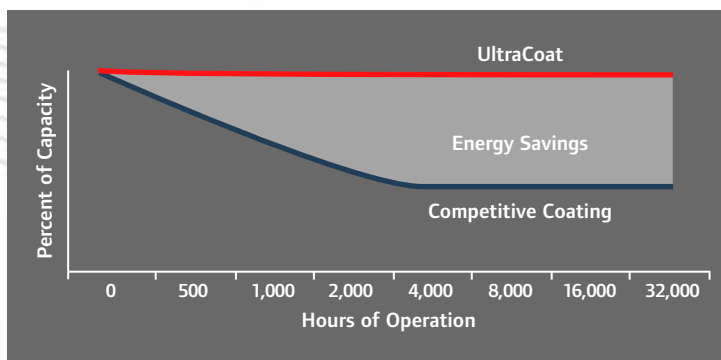

A smart choice for reliable, repeatable processes

50 Hz (37 – 300 kW)							
Nominal kW	Model SL FAD (m ³ /min) at 7.0 bar g	Model SM FAD (m ³ /min) at 8.5 bar g	Model SH FAD (m ³ /min) at 10.0 bar g mm	Width mm	Length mm	Height kg	Weight
37	6	5.1	N/A	1372	2248	1914	2387 / 2410**
45	7.6	6.5	N/A	1372	2248	1914	2497 / 2520**
55	9.6	8.6	7.7*	1372	2248	1914	2577 / 2600**
75	12.5	11.6	10.7*	1372	2248	1914	2682 / 2705**
90	15.9	13.6	13	1588	2692	2362 / 1841 **	3040 / 3195**
110	19.4	18	15.3	1588	2692	2362 / 1841 **	3095 / 3250**
132	22.8	21.4	18.8	1588	2692	2362 / 1841 **	3274 / 3429**
150	25.9	24.6	22.1	1588	2692	2362 / 1841 **	3275 / 3430**
200	35	32.6	27.4	1930	3048	2438 / 2032 **	4186
250	45.2	41.5	35.5	1930	3048	2438 / 2032 **	4306
300	43.6	43.5	43.3	1930	3048	2438 / 2032 **	4366

60 Hz (50 – 400 hp)							
Nominal hp	Model L FAD at 100 psig cfm	Model H FAD at 125 psig cfm	Model HH FAD at 150 psig cfm	Width in	Length in	Height in	Weight lbs
50	214	179	N/A	54	88.5	75.4	5111
60	266	229	N/A	54	88.5	75.4	5364
75	333	288	268*	54	88.5	75.4	5364
100	419	407	378*	54	88.5	75.4	5500
125	585	523	477	62.5	106	93.3 / 72.5**	6437 / 6709**
150	690	690	565	62.5	106	93.3 / 72.5**	6452 / 6724**
200	911	854	759	62.5	106	93.3 / 72.5**	7099 / 7385**
250	1,182	1,070	905	76	120	96 / 80**	8820
300	1,398	1,264	1,112	76	120	96 / 80**	9090
350	1,600	1,501	1,330	76	120	96 / 80**	9610
400	1,539	1,535	1,527	76	120	96 / 80**	9610

FAD (Free Air Delivery) cfm and m³/min are full-package performance ratings in accordance with CAGI / Pneurop acceptance test standard PN2CPTC2 or ISO 1217.

*Available in water-cooled configuration only.

**Specification given with air-cooled value first, then water-cooled.

Advanced controls

If you have a multiple-compressor installation, then you probably know that maintaining optimum average pressure along the entire line can be challenging, inefficient, and costly. Load / unload pressures are commonly offset to keep the compressors from starting at the same time, but doing so limits the system's ability to meet demand, and basic control settings can drift over time. This causes wide pressure swings that result in off-quality product, wasted energy, and shortened compressor life.

Ingersoll Rand advanced controllers — when coupled with our extensive system audit services — enable you to optimise air efficiency, deliver consistent flow and pressure, and extend the life of system components. Ultimately, you'll stabilise your pressure and reduce energy costs.

Intelliflow™ Air System Pressure Controller

Intelliflow provides precise air pressure control of production processes by separating supply-side air from demand-side air. As a result, supply-side air is not affected by incidents on the demand side. Intelliflow can lower demand pressure precisely — saving lost energy costs and better ensuring consistent product quality.

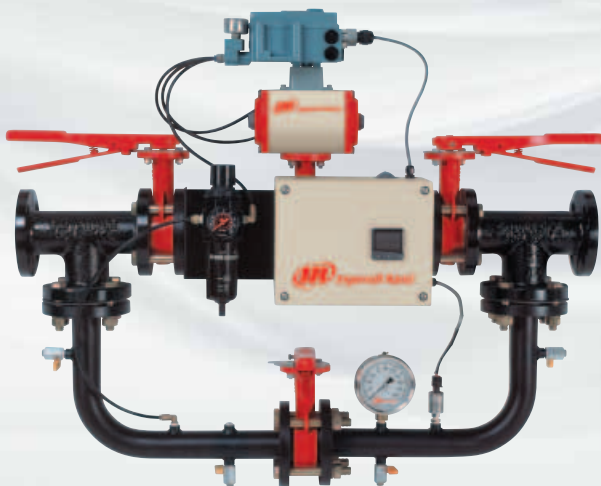

Intellisys Energy Optimizer

When incorporated into a Nirvana VSD-enhanced, fixed-speed compressed air system, the IEO provides the utmost in energy savings. The controller designates the Nirvana as a "trimming" or "lead" compressor. If only one compressor is needed to satisfy demand, the more efficient Nirvana will run. When demand exceeds the capacity of the Nirvana, one or more of the fixed-speed compressors will start at full capacity and the Nirvana trims back in output to precisely and efficiently satisfy demand in excess of the fixed-speed capacity. As demand drops, the IEO turns off the fixed-speed units, leaving the Nirvana to run by itself again.

Enhance reliability

Control up to eight rotary-screw or reciprocating compressors from any manufacturer, and continuously monitor air system quality.

Save energy

Overcome the problems associated with compressor trains and reduce the control pressure band.

Increase productivity

Automate compressor control and optimise compressor scheduling to meet varying plant demand.

Symptom...diagnosis...prescription

Ingersoll Rand can improve the health of your air system

A doctor wouldn't write a prescription without first making a diagnosis. Similarly, in terms of compressed air, fixing a troublesome system without first diagnosing the true problem is a hit or miss proposition based on guesswork. This can lead to production stoppages, extended downtime, and even product spoilage. Ingersoll Rand eliminates the guesswork by providing proven air system auditing services that not only ensure air system efficiency, but reduce operating costs to improve bottom lines.

Using an innovative tool — known as Intellisurvey — we non-intrusively monitor a compressed air system to determine the root causes of symptoms. With Intellisurvey, our experts analyse the many components of an air system, as well as flow, pressure, supply utilisation, and power costs, to determine an optimized system that generates improvements in repeatability, efficiency, and plant productivity.

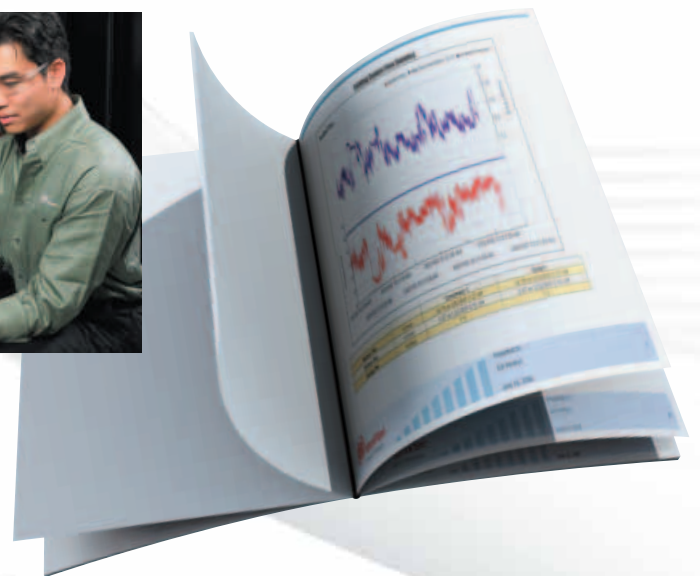

Global reach, local service

No matter where your facility is located, Ingersoll Rand is committed to serving you 24-hours a day, seven days a week. Our worldwide network of certified, factory-trained technicians and engineers are a phone call away — ready to support you with innovative and cost-effective service solutions that will keep you running at peak performance.

AirCare Advantage

We understand that uptime is critical to your operation. That's why we offer AirCare Advantage — a responsive, flexible contract maintenance program custom-designed to provide factory-authorized scheduled maintenance that ensures increased system reliability. AirCare Advantage helps eliminate unscheduled downtime and relieves you of costly investments in monitoring equipment and ongoing training. The program also provides a thorough knowledge of compressor technology.



No matter what, count on Ingersoll Rand

Even if you run an air compressor from another manufacturer, you can count on Ingersoll Rand to keep you up and running without a hitch. No matter what the make or model, Ingersoll Rand builds replacement parts designed to the same specifications and operational efficiencies you'd expect from the original equipment manufacturer (OEM).

Whether for parts, preventive maintenance, or timely repairs, who better to maintain your compressed air system than the company who leads the world in building them . . . Ingersoll Rand.



Maximize uptime with Ingersoll Rand parts and service.



Ingersoll Rand Industrial Technologies provides products, services and solutions to enhance the efficiency and productivity of our commercial, industrial and process customers. Our innovative products include air compressors, air systems components, tools, pumps, material and fluid handling systems and microturbines.

air.ingersollrand.com

Ingersoll Rand European Sales Limited
Swan Lane, Hindley Green,
Wigan WN2 4EZ, UK
Tel: +44 (0) 1942 257171
Fax: +44 (0) 1942 254162

Ingersoll Rand compressors are not designed, intended or approved for breathing air applications. Ingersoll Rand does not approve specialised equipment for breathing air applications and assumes no responsibility or liability for compressors used for breathing air service.

Nothing contained on these pages is intended to extend any warranty or representation, expressed or implied, regarding the product described herein. Any such warranties or other terms and conditions of sale of product shall be in accordance with Ingersoll Rand's standard terms and conditions of sale for such products, which are available upon request.

Product improvement is a continuing goal at Ingersoll Rand. Designs and specifications are subject to change without notice or obligation.